

G Series Technical Guide – 9959 Impeller

Identification



G30-2 & G30-2B



G21



G9901 & G9903*



K75 & K75B



J70



G15

*(G9901 - 6 1/2" pulley; G9903 - 4" pulley)

Assembly / Disassembly Instructions

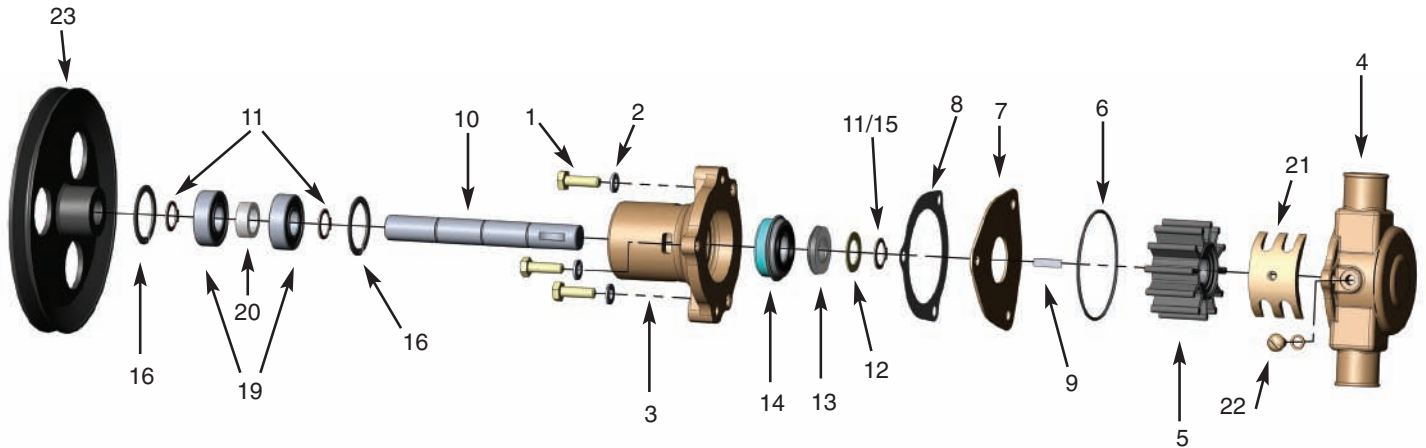

The following assembly/disassembly procedures apply to all G Series pumps. Deviations from pump to pump are primarily a result of different methods of drive and mounting.

Disassembly:

- A. Remove the screws (1) and lockwashers (2) that hold the body (3) and housing (4) together.
- B. The housing assembly including the impeller (5) can be removed from the body assembly, along with the o-ring (6), spacer plate (7) and gasket (8).
- C. Remove the woodruff key (9) from the shaft (10). If the shaft is to be used again, and if it is put in a vise, always use lead over the jaws of the vise so that the shaft is not damaged.
- D. Remove the retaining ring (11 or 15) from the shaft (impeller end). The shoulder washer (12) and seat assembly (13) can now be removed.
- E. From the drive end of the pump (pulley end, hub end, shaft end), remove retaining ring, remove pin (17), remove woodruff key (18) and loosen setscrew if used. NOTE: If the pulley (23) or hub (24) is pressed on the shaft, it will be necessary to locate a support directly between the pump body and pulley or hub as close to the shaft as possible. Press the shaft out of the pulley or hub. Make sure the body is free and not supported.
- F. Remove the large internal retaining ring (16) from the body at the end of the bearing.
- G. Support the body, and press the shaft, bearings (19), spacer (20) and retaining rings (11) out through the bearing or pulley end of the body.
- H. The seal assembly (14) is pressed into the body. It can be removed by pushing a tool through the bearing end and up against the metal or back side of the seal. NOTE: On some pumps there is a spacer located between the pulley (hub) and bearing on the shaft. On other pumps, the bearings are positioned on the shaft with a retaining ring on each end. Support the bearings on the inner race, and push the shaft out of the bearings.

Assembly:

- A. When assembling the cam (21), put Permatex #1 on the backside of the cam and the screw (22) that retains the cam. Wipe off any Permatex that gets into the impeller cavity.
- B. Assemble a retaining ring (11) on the shaft into the second groove from the impeller end. Push the ball bearing (19) over the shaft (10). Press on the inner race of the bearing. Push the bearing up against the retaining ring. Assemble a spacer and then the second ball bearing. Assemble the second retaining ring over the shaft and up against the ball bearing, if required.
- C. There is a large internal retaining ring (16) located in the body that provides a shoulder for the bearings (approximately 1.38" from the bearing end of the body). If it has been removed, it must be inserted at this time.
- D. Press the mechanical seal (14) into the body from the impeller end. Make sure that seal is pressed in square. A tool should be used to assure proper assembly.
- E. Push the bearing and shaft assembly into the body using care not to cock the bearing. A tool is recommended that will give you uniform pressure on the bearing outer race. Lock the bearing in place with the large internal retaining ring.
- F. Assemble the seat assembly (13), shoulder washer (12) and retaining ring (11 or 15) over the shaft from the impeller end. Locate the white ceramic surface against the seal – Do not damage (scratch) the white ceramic surface of the seat, or the seal and seat assembly might leak. Lubricate the rubber part of the seat and use a tool for ease of assembly.
- G. While supporting the shaft, press the pulley (23) or hub (24) onto the shaft. Secure pulley/hub with pin (17) or key (18) and retaining ring or setscrew as needed.
- H. Press the woodruff key (9) into the shaft. Make sure the stainless steel key is used at this location.
- I. Assemble the impeller (5) into the housing (4).

Assembly / Disassembly Instructions (continued)

- J. Assemble the gasket (8) and spacer plate (7) on the body (3), and line up the screw holes. Replace the lockwashers (2) and tighten the screws (1).
- K. Make sure the o-ring (6) is properly located in the groove in the housing. A small dab of grease will help hold it in position until the housing to body screws are tightened.

Sherwood #		G15	G21	G30-2B	G30-2	G9901	G9903	J70	K75B
Engine Manufacturer		Chris Craft		Chris Craft	Chris Craft	Volvo/OMC	Volvo/OMC	Commander	
Engine Model		350		350	350	6&8 Cyl	4 Cyl	302&351	
ITEM	QTY			16.80-18346	16.80-18346	3852398	3855079	CM1-10-610	
1	Screw	3	12857	12857	12857	12857	12857	12857	12857
2	Lockwasher	3	12710	12710	12710	12710	12710	12710	12710
3	Body	1	12324	12328	19784	12328	21153	21759	12328
4	Housing	1	12303	12303	12303	12303	21151	21151	12303
5	Impeller	1	9959	9959	9959	9959	9959	9959	9959
6	O-ring	1	12231	12231	12231	12231	12231	12231	12231
7	End Plate	1	12856	12856	12856	12856	12856	12856	12856
8	Gasket	1	12855	12855	12855	12855	12855	12855	12855
9	Key	1	4432	4432	4432	4432	4432	4432	4432
10	Shaft	1	12233	13363	12612	12612	13363	13363	13274
11	Retaining Ring (Ext)	2/3	4258	4258	4258	4258	4258	4258	4258
12	Washer	1	4264	4264	4264	4264	4264	4264	4264
15	Retaining Ring (Ext)	1	12305						
16	Retaining Ring (Int)	2	4259	4259	4259	4259	4259	4259	4259
17	Pin	1			12791	12791			
18	Key	1	12622					12622	
19	Ball Bearing	2	23448	23448	23448	23448	23448	23448	23448
20	Spacer	1	5133	5133	5133	5133	5133	5133	5133
21	Cam	1	15883	15883	15883	15883	15883	15883	15883
22	Cam Screw	1	10515	10515	10515	10515	10515	10515	10515
23	Drive Pulley or Gear	1	12323	19729			21154	21175	13429
24	Hub	1			12615	12615			13795
13/14	Water Seal/Seat Assy	1	12859	12859	12859	12859	12859	12859	12859
	Minor Repair Kit		23979	23979	23979	23979	23979	23979	23979
	Major Repair Kit		12665	12665	12665	12665	12665	12665	12665

Inspection

The #1 reason for premature engine wear is overheating. To maintain engine performance, insist upon genuine Sherwood impellers and service kits.

Recommended inspection to be performed at any service interval:

- Impeller Inspect for cracks or tears. Also, inspect for excessive abrasion of vane ends. Replace annually, or if any of the conditions exist, as in the picture below.*
- Wear Plate Inspect for wear, flatness, and pin for fatigue. Replace at minor and major pump rebuild or if wear is evident to maintain pump flow and suction performance
- Cam Replace at major pump rebuild or if pitting/wear is evident.
- Cover Replace at major pump rebuild or if wear exists to maintain pump flow and suction performance.
- Mechanical Seal Replace at minor and major pump rebuild or if leaking.
- Lip Seal Replace at minor and major pump rebuild or if leaking.
- Shaft Inspect for wear in area of lip seal and rubber impeller. Grooving of lip seal area or heavy fretting of the impeller end shaft will require shaft replacement.
- Bearing Inspect for loss of grease, corrosion or rough rotation. Replace at major pump rebuild or if in doubt.

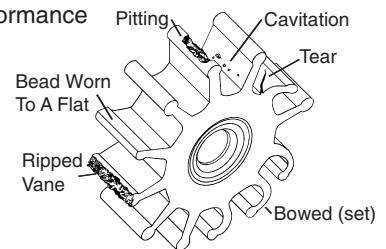

* See maintenance schedule on back page

Preventative Maintenance

Maintenance Schedule	Pleasure Boating (Low Hours)		Commercial/Fishing Use (High Hours)	
	Light Duty	Severe Duty (High RPM, Silt or Sand)	Heavy Duty	Severe Duty (High RPM, Silt or Sand)
Impeller Kit	Every year	6 months	6 months	3 months
Minor Kit	2 years	Every year	Every year	6 months
Major Kit	4 years	2 years	2 years	Every year

	Impeller Kit 09959K	Minor Kit 23979	Major Kit 12665
	1-09959 Impeller 1-12231 O-Ring 1-12855 Gasket	1-09959 Impeller 1-12231 O-Ring 1-12855 Gasket 1-12859 Seal 1-04258 Snap Ring 1-04432 Key 1-04264 Washer 2-04259 Snap Rings	1-09959 Impeller 1-12231 O-Ring 1-12855 Gasket 1-12859 Seal 3-04258 Snap Ring 1-04432 Key 1-04264 Washer 2-04259 Snap Rings 2-23448 Bearings 1-12856 End Plate 1-15883 Cam 1-10515 Cam Screw
G15	X	X	X
G21	X	X	X
G30-2B	X	X	X
G30-2	X	X	X
G9901	X	X	X
G9903	X	X	X
G55-2	X	X	X
J70	X	X	X
K75B	X	X	X



HYPRO[®]

Pentair Water
MARINE PRODUCTS GROUP

375 Fifth Avenue NW • New Brighton, MN 55112
Phone: (651) 766-6300 • 800-471-0460 • Fax: 800-672-7023
www.sherwoodpumps.com

SHERWOOD[®]